

RADA VR115 VANDAL RESISTANT SHOWER FITTING



- WRAS Approved
- KIWA Approved
- Vandal resistant shower head
- Durable polished chrome finish
- Optional security plate for increased vandal resistance
- 15 mm compression connection
- Fitted with single spray pattern plate with adjustable angle of discharge
- Fitted with 9 litres/minute flow regulator (6 litre regulator available)



Specify as: Rada VR115 (1.0.098.83.1)

Vandal resistant shower fitting for connection to concealed pipework with fixed spray plate and 9 l/min flow regulator.

Dimensions (mm)

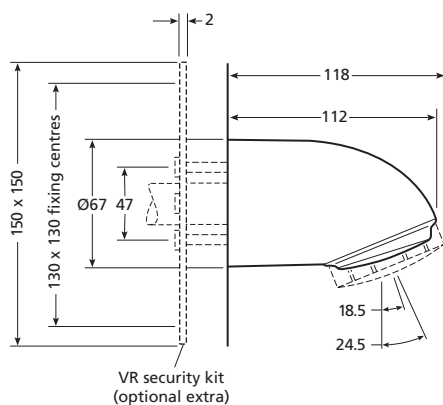

Pressure Loss/Flow Rate (with VR spray plate)

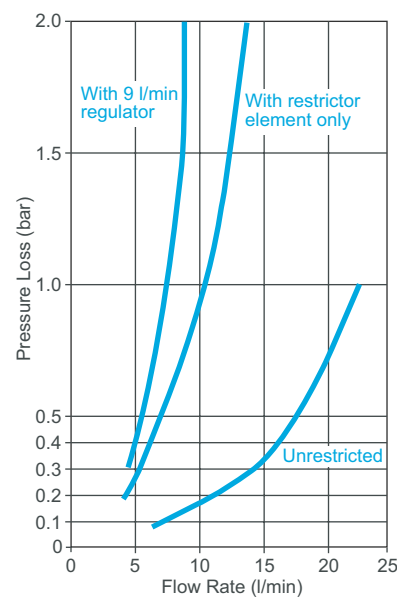

Spray Patterns at 9 l/min

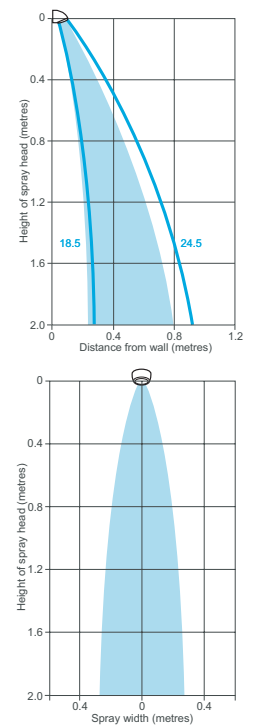

TECHNICAL SPECIFICATION

Installation and Maintenance

Please refer to the appropriate Product Manual.

Connections

15 mm compression connection to concealed pipework.

Approvals

WRAS Approved (Water Regulations Advisory Scheme)
 Designed, manufactured and supported in accordance with accredited
 BS EN ISO 9001:2000 Quality Management Systems and
 BS EN ISO 14001:2004 Environmental Management Systems.

Materials

Spray body: Brass, polished chrome finish.
 Mounting bush/Inlet nipple: Brass.
 Spray cartridges: Engineering plastic.
 Flow Regulator: Engineering plastic.
 Strainer: Stainless steel.
 VR security plate: Plated mild steel.
All screws in contact with water are stainless steel.

Temperature Range

Designed to accept water supplied between 5°C and 65°C.

Pressure Range

Recommended minimum maintained pressure at the inlet of the fitting: 0.1 bar.
 Maximum maintained pressure at the inlet of the fitting: 5.0 bar.

Spray Performance

Minimum flow rate necessary to achieve a fully formed spray pattern:
 6 litres/min.

Accessories

300R Adjustable Spray Cartridge (1.0.098.87.1)

With 'Start', 'Active' and 'Relax' modes (chrome finish).

310R Hard Water Spray Cartridge (1.0.098.88.1)

Self-draining with 'push-clean' action (chrome finish).

VR Security Kit (5.936.94.1.0)

Concealed mounting plate offering even greater security, for use with VR105/VR115.

Note! For 'high risk' applications the 300R, 310R and 400R spray cartridges are not recommended as the cartridges may be removed without the use of tools.

Pressure Loss/Flow Rate (with 300R spray cartridge)

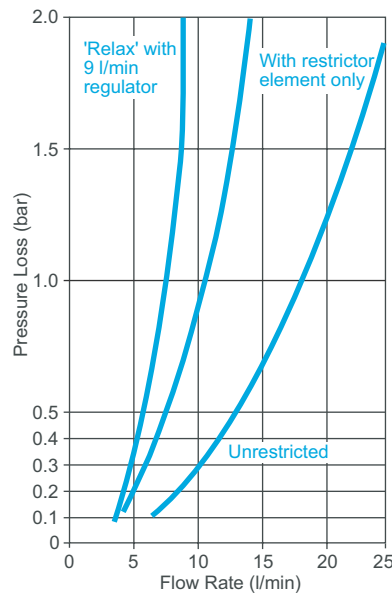

Spray Patterns at 9 l/min

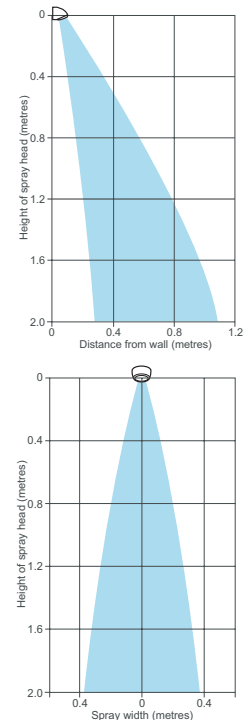

Pressure Loss/Flow Rate (with 310R spray cartridge)

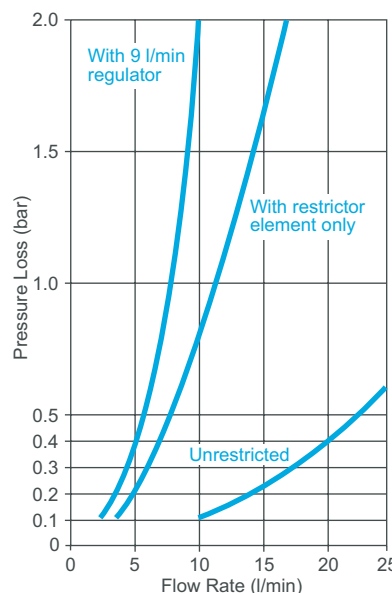

Spray Patterns at 9 l/min

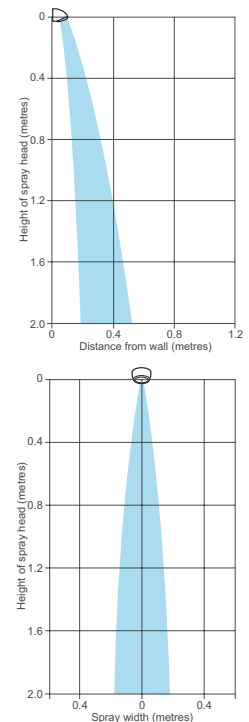

Kohler Mira Limited
 Cromwell Road, Cheltenham
 Gloucestershire, GL52 5EP

Specification Enquiries
 Tel: 0844 571 1777, Fax: 0844 472 3076
 Email: rada_technical@mirashowers.com
 www.radacontrols.com

Rada is a registered trademark of Kohler Mira Limited.
 The company reserves the right to alter product specification without notice.
 © January 2012 Kohler Mira Limited. All rights reserved.
 No part of this document, or any accompanying document, may be reproduced or transmitted in any form or by any means, including photocopying or electronically, without the permission of Kohler Mira Limited.

A **KOHLER** COMPANY



FM 14648

